

ASSEMBLY INSTRUCTION SR414

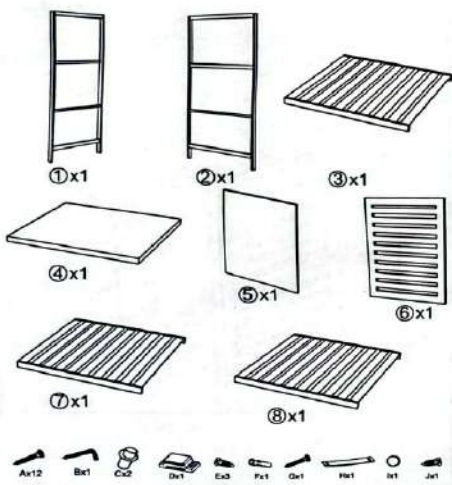

STEP1

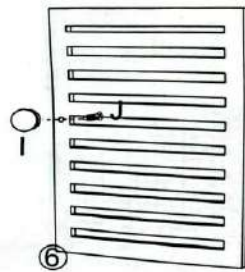

STEP2

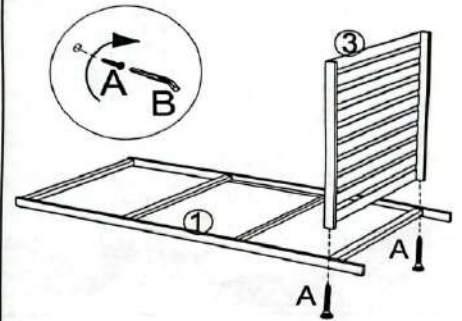

STEP3

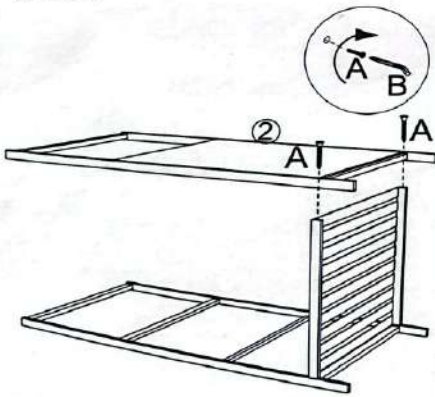

STEP4

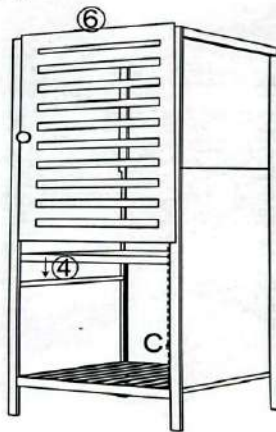

STEP5

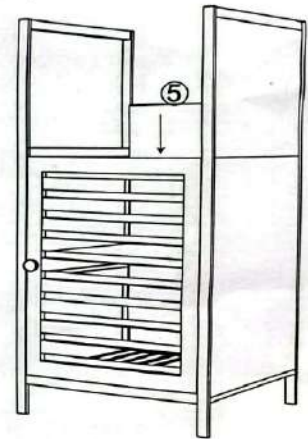

STEP 6

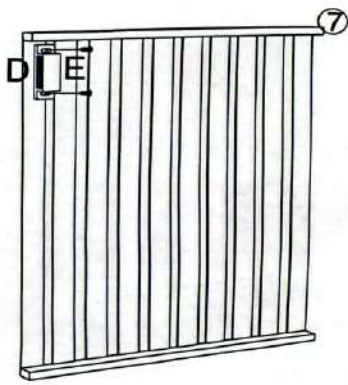

STEP 7

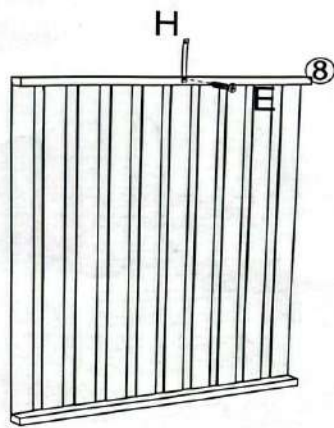

STEP 8

